



BALLAST SPECIFICATION

250W M138 / M153

Pulse Start Metal Halide

V90D8411

60 Hz CWA C&C

Input Volts	120	208	240	277
Line Current (Amps)				
Operating	2.45	1.45	1.25	1.05
Open Circuit	1.80	1.10	0.90	0.80
Starting	1.75	1.00	0.90	0.75
Recommended Fuse (Amps)	7	4	4	3
Regulation				
Line Volts	±10%	±10%	±10%	±10%
Lamp Watts	±9%	±9%	±9%	±9%
Temperature Ratings				
Insulation Class	180 (H)	180 (H)	180 (H)	180 (H)
Coil Temperature Code	A	A	A	A
Benchtop Coil Rise	63.7	66.4	65.6	65.4
Power Factor (%) HPF	90	90	90	90
Input Watts	284 W	284 W	284 W	284 W
Efficiency	88.0%	88.0%	88.0%	88.0%
NOM. Open Circuit Voltage	275	275	275	275
Input Voltage At Lamp Dropout	65	110	125	145
Min Ambient Starting Temp	-20°F/-30°C*	-20°F/-30°C*	-20°F/-30°C*	-20°F/-30°C*
60 HZ TEST PROCEDURES				
High Potential Test (Volts)				
1 Minute	1,600 V	1,600 V	1,600 V	1,600 V
1 Second	1,900 V	1,900 V	1,900 V	1,900 V
Open Circuit Voltage Test (V)	250 - 300	250 - 300	250 - 300	250 - 300
Short Circuit Current Test (A)				
Secondary Current Min	2.30	2.30	2.30	2.30
Max	2.85	2.85	2.85	2.85
Input Current Min	1.35	0.80	0.65	0.60
Max	2.05	1.20	1.00	0.90
CORE and COIL Specifications				
Dimension (A)	2.00 in	2.00 in	2.00 in	2.00 in
Dimension (B)	4.10 in	4.10 in	4.10 in	4.10 in
Weight	10.0 lb's	10.0 lb's	10.0 lb's	10.0 lb's
Lead Lengths	12 "	12 "	12 "	12 "
Capacitor Requirement				
Microfarads	16.0 uf	16.0 uf	16.0 uf	16.0 uf
Volts (Min)	370 V	370 V	370 V	370 V

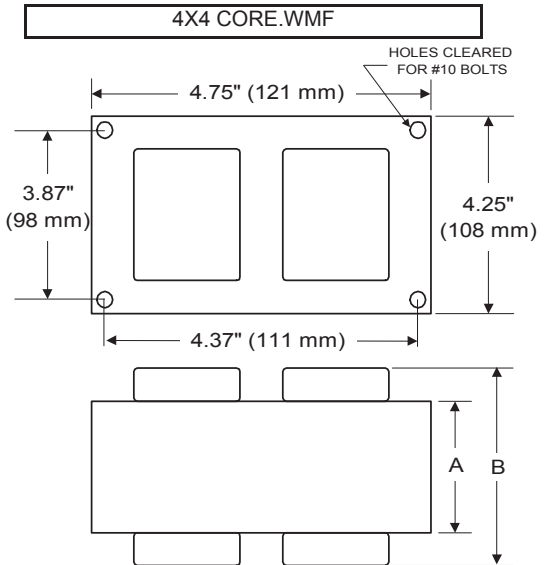

Capacitor: ACB2010V / ACG328	Ignitor: BVS-041
Microfarads: 16.0 uf 16.0 uf	Case Temp (Max): 105 °C
Volts (Max): 370 V 400 V	BTL Distance (Max) 2 ft
Case Temp (Max) 100 °C 100 °C	
Height (Max): 3.25 in 3.74 in	
Dia (Max): 1.97 in 1.80 in	
Oval Width (Max): 2.97 in	

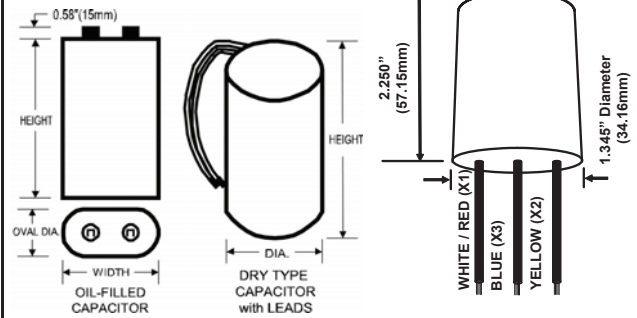

Ordering Information Add Suffix for options

- C - With Oil-Filled Capacitor
- CB - With Oil-Filled Capacitor and Welded Bracket
- B - With Welded Bracket, no Capacitor
- K - Prewired, with Dry Capacitor and Bracket Kit
- D - With Dry Capacitor
- DB - With Dry Capacitor and Welded Bracket

* -40°F/-40°C Min Ambient Starting Temp with Venture Lamp

Data is based upon tests performed by Venture Lighting in a controlled environment and is representative of relative performance. Actual performance can vary depending on operating conditions. Specifications are subject to change without notice.

08/25/2022 Production Coil Material (PRI/SEC): AI / AI

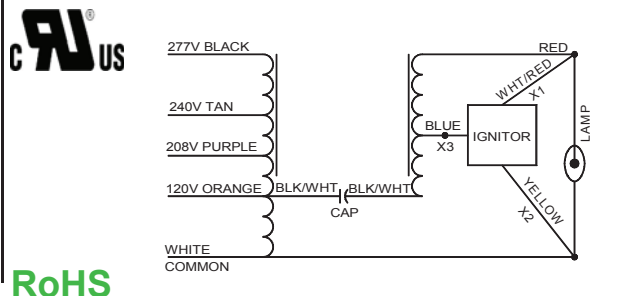

RoHS